

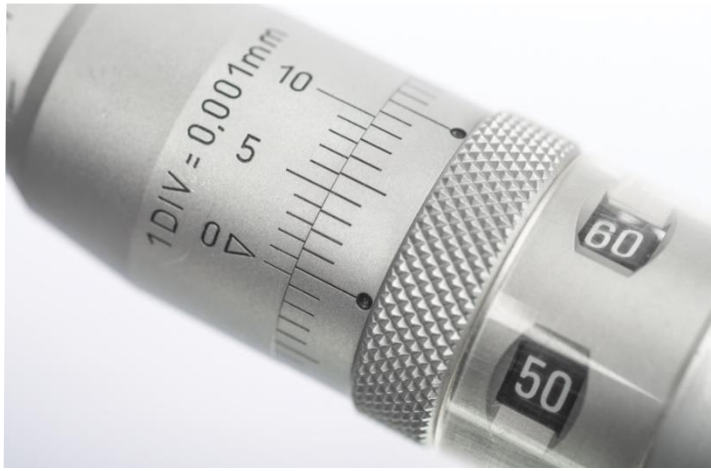

**TESA**  
TECHNOLOGY

# QUICK DEALS

## 2024-2

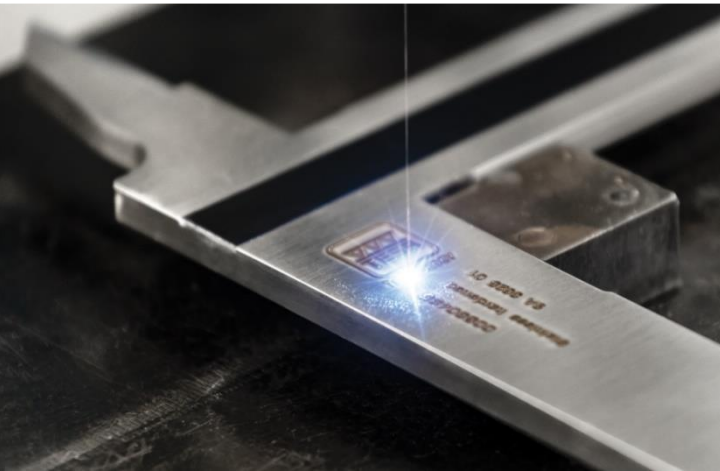
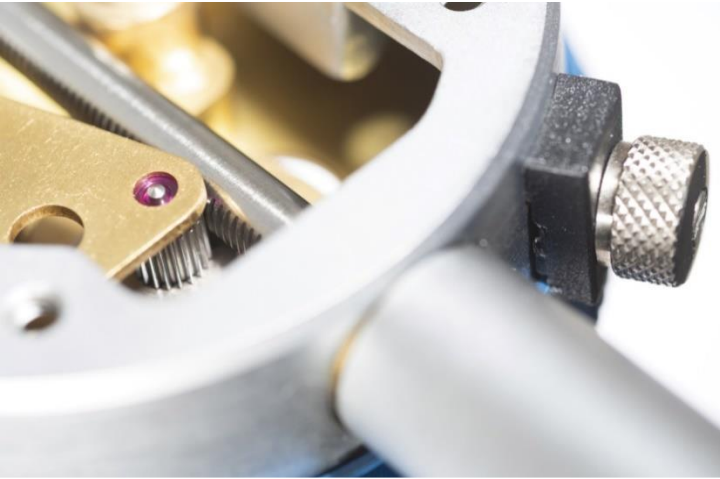

# Poslední PŘÍLEŽITOST

## Sleva až **73%** z ceníkových cen

Nabídka platí do vyčerpání zásob

Ceny v EUR bez DPH  
EN – EUR

[TESAtechnology.com](https://www.tesatechnology.com)

# Univerzální analogové posuvky

## Metrická verze:

- TESA
- kruhový hloukoměr
- DIN 862

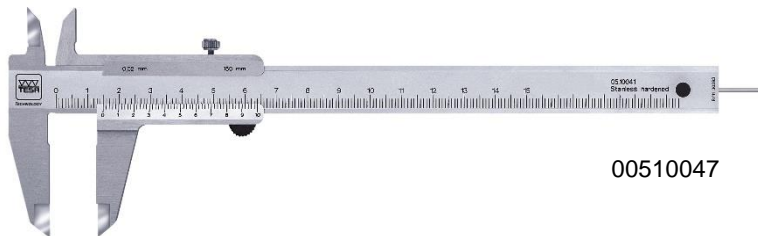

00510047

Item Number	Description	Reading	List Price EUR	Rebate	Promo Price EUR
00510047	TESA 150 mm RD	0,05 mm	37€	32%	25€

## Verze mm/inch:

- Etalon
- plochý hloukoměr
- DIN 862

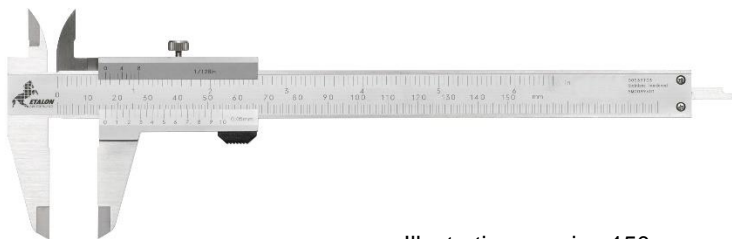
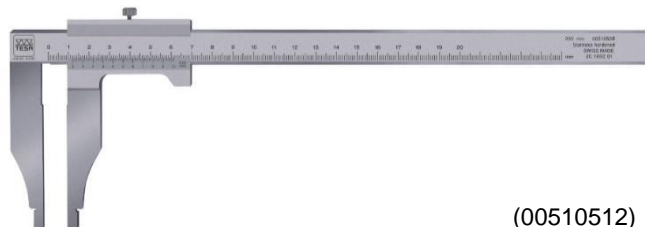

Illustration: version 150 mm

Item Number	Description	Reading	List Price EUR	Rebate	Promo Price EUR
00539104	ETALON 200 mm / 8in SQ	0,05 mm / 1/128 in	82€	56%	36€
00539105	ETALON 300 mm / 12in SQ	0,05 mm / 1/128 in	192€	66%	66€

## Dílenská posuvka pro měření velkých rozměrů

- TESA
- DIN 862



(00510512)

Item Number	Measuring Range	Reading	List Price EUR	Rebate	Promo Price EUR
00510531	0 ÷ 400 mm	0,02 mm	282€	35%	183€

## Model s horními čelistmi

- TESA
- DIN 862

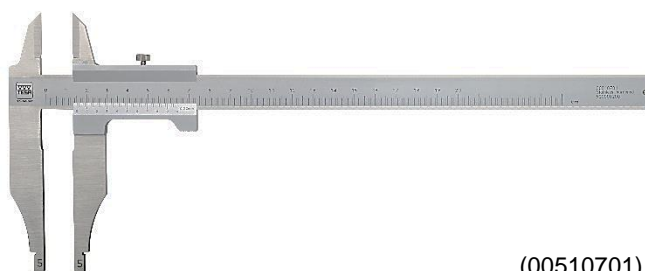

(00510701)

Item Number	Measuring Range	Reading	List Price EUR	Rebate	Promo Price EUR
00510711	0 ÷ 250 mm	0,02 mm	126€	52%	60€



## Analogový hloubkoměr

- TESA standardní model
- Plochá měřicí plocha
- DIN 862

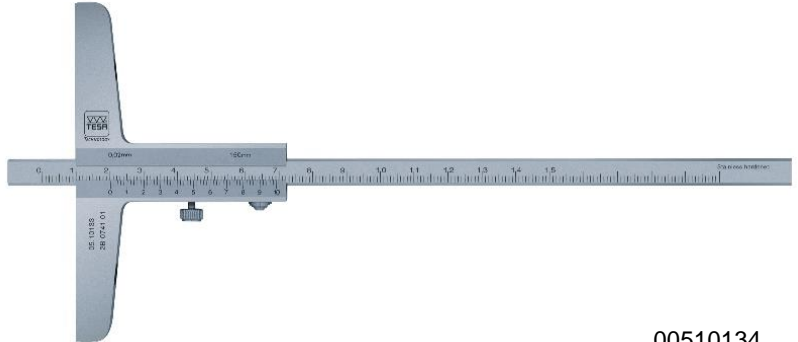

00510134

Item Number	Measuring Range	Reading	List Price EUR	Rebate	Promo Price EUR
00510134	0 ÷ 150 mm	0,05 mm	79€	38%	49€
00510163	0 ÷ 500 mm	0,02 mm	126€	42%	73€
00510173	0 ÷ 600 mm	0,02 mm	224€	56%	98€

## Analogový hloubkoměr

- TESA convertible model
- Měřicí stupnici lze otočit pro záměnu kontaktní plochy
- Háček / plochý úzký dotek
- DIN 862

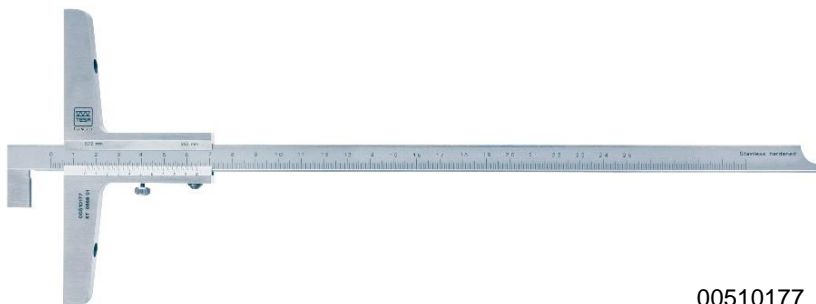

00510177

Item Number	Measuring Range	Reading	List Price EUR	Rebate	Promo Price EUR
00510175	0 ÷ 150 mm	0,02 mm	109€	49%	56€
00510177	0 ÷ 250 mm	0,02 mm	143€	59%	59€
00510179	0 ÷ 300 mm	0,02 mm	136€	52%	65€
00510181	0 ÷ 500 mm	0,02 mm	248€	68%	79€

- TESA
- s otočným dotekem
- DIN 862



00510201

Item Number	Measuring Range	Reading	List Price EUR	Rebate	Promo Price EUR
00510201	0 ÷ 150 mm	0,05 mm	113€	42%	66€
00510202	0 ÷ 150 mm	0,02 mm	226€	71%	66€
00510221	0 ÷ 500 mm	0,05 mm	279€	32%	190€
00510222	0 ÷ 500 mm	0,02 mm	189€	58%	80€

## Speciální posuvky

- 2 varianty měření vnitřních otvorů



00510915

Item Number	Description	Measuring Range	Reading	List Price EUR	Rebate	Promo Price EUR
00510915	With knife-edge jaws for internal dimensions	0 ÷ 250 mm	0,02mm	282€	73%	76€

## Analogový mikrometr se 7 páry výměnných doteků

- Nerotující vřeteno d=8mm
- Maximální chyba: 4μm
- 7 párů měřicích doteků:
  - Ploché: Ø 6,5 mm, Ø 2 mm, Ø 12 mm
  - Sférický: R = 5 mm
  - Ploché, zúžený: 0,7 mm
  - Kuželový: Ø 0,3 mm / 60°
  - Nožový: 0,3 mm / 60°



00219062

Item Number	Measuring Range	Reading	List Price EUR	Rebate	Promo Price EUR
00219056	0 ÷ 25 mm	0,01 mm	497€	44%	280€

## Analogové úchylkoměry

- ISO 463
- Kovové tělo
- Válcová část vyrobena z tvrzené nerez oceli
- Toleranční značky
- Měřicí dotek se závitem M2,5



355E



01410211

Item Number	Measuring Range	Reading	Diameter	Circular scale	Shock-proof	List Price EUR	Rebate	Promo Price EUR
<i>Compac models</i>								
<b>532PF1</b>	10 mm	0,01 mm	58 mm	100 ÷ 50 ÷ 0	Yes	311€	73%	<b>85€</b>
<b>533S</b>	± 0,5 mm	0,01 mm	58 mm	50 ÷ 0 ÷ 50	Yes	385€	26%	<b>284€</b>
<b>567E</b>	1 mm	0,001 mm	58 mm	0 ÷ 5 ÷ 10	Yes	481€	21%	<b>378€</b>
<b>CL2532</b>	3 mm	0,01 mm	58 mm	0 ÷ 50 ÷ 100	Yes	1473€	28%	<b>1065€</b>

## Přesné libely

- Pro kontrolu a ustavování ploch nebo válcových povrchů v horizontální poloze
- Libela s tepelně izolovaným gripem se sloty pro boční pohled



053314..00/01/13



05331064

Item Number	Description	Dimensions	Scale interval	List Price EUR	Rebate	Promo Price EUR
05331400	Prismatic level	30 x 10mm	2 ÷ 5mm/m	303€	27%	220€
05331401	Prismatic level	40 x 10mm	2 ÷ 5mm/m	311€	30%	218€
05331413	Prismatic level	120 x 18mm	0,1mm/m	484€	38%	302€
05331064	Spirit level	300 x 50 x 42mm	0,04 mm/m	988€	35%	644€

## Přesné libely

- DIN 877
- Max. chybadle DIN 2276 Part 1



053312..52/58



05331207

Item Number	Description	Dimensions	Scale interval	List Price EUR	Rebate	Promo Price EUR
05331252	Flat measuring face	100 x 10, Ø 20	0,1 mm/m	407€	49%	206€
05331258	Flat measuring face	200 x 12, Ø 22	0,1 mm/m	509€	43%	289€
05331207	Frame spirit level	200 x 200 x 40	0,04 mm/m	1455€	37%	912€





**TESA**  
TECHNOLOGY

## TESA úhломěr

- ploché a prizmatické měřicí plochy



05331300

Item Number	Description	Dimensions	Circular scale	Scale interval	List Price EUR	Rebate	Promo Price EUR
05331300	Protractor spirit inclinometer	180 x 75 x 22	4x 90°	1°	1289€	27%	938€



**TESA**  
TECHNOLOGY

## Stojánky pro úchylkoměry

- Magnetický stojánek INTERAPID



01639053

Item Number	Description	Dimensions	Force	List Price EUR	Rebate	Promo Price EUR
01639053	High precision Fine adjustment	444 mm	1000 N	784€	41%	465€



## Stojánky pro úchylkoměry

- Magnetický stojánek INTERAPID

01639018



Item Number	Description	Dimensions	Force	List Price EUR	Rebate	Promo Price EUR
01639018	Magnetic support	306 x 270 mm	1000 N	679€	35%	440€

## Sondy

- FMS 100 2 mm

03230119



Item Number	Description	Measuring Range	Measuring force	List Price EUR	Rebate	Promo Price EUR
03230119	FMS100 2MM Detachable	± 2 mm	2 N	707€	32%	480€

# Sada 10 sond



Item Number	Description	Measuring Range	Measuring force	List Price EUR	Rebate	Promo Price EUR
03230227	Set of 10 probes GT27 Detachable	± 2 mm	0,63 N	3992€	35%	2600€
03290235	Set of 10 probes GT62 Detachable	± 5 mm	0,9 N	4388€	32%	3000€
03290241	Set of 10 probes GT282 Detachable	± 2 mm	1 N	4521€	33%	3050€
03290273	Set of 10 probes GT282-A Detachable	± 2 mm	0,85 N	4600€	33%	3100€